





Een stijlvol interieur en behaaglijke warmte. Deze wensen worden vervuld met de Plieger designradiatoren. Een breed programma met allerlei vormen en maten kenmerkt de Plieger design radiatoren. Voor elke ruimte kan Plieger uw warmtevraag beantwoorden.

Uiterlijk en innerlijk

Een ruimte wordt gesierd door alles wat er in aanwezig is. De Plieger designradiatoren zijn naar eigen smaak uit te zoeken. Van sierlijk tot trendy en in verschillende kleuren verkrijgbaar. Warmte in koude tijden is een belangrijk onderdeel van het woongenot. Plieger voorziet hierin door een diversiteit aan warmteafgifte.

Duurzaam

Plieger designradiatoren worden vervaardigd volgens de Europese normen en voldoen aan de geldende kwaliteitseisen. Degelijke productie en hoogwaardige afwerking zorgen voor een duurzame designradiator die jarenlang woonplezier garandeert.

De mooiste vorm van kwaliteit

Quadro

Palermo

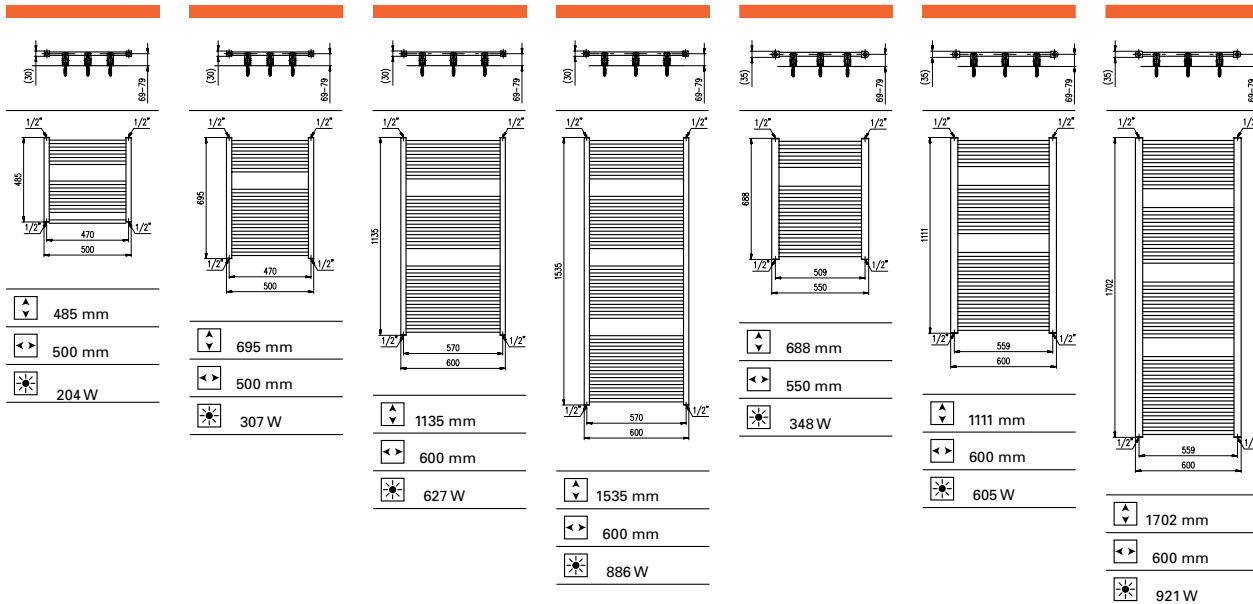

Zie pagina 17 voor alle leverbare kleuren

Inclusief bevestigingsset, montagehandleiding, ontlufter en blindstop

Onda

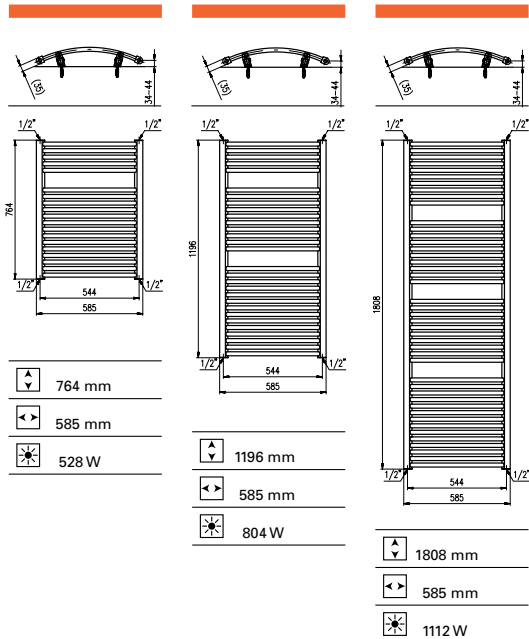

Florian enkel

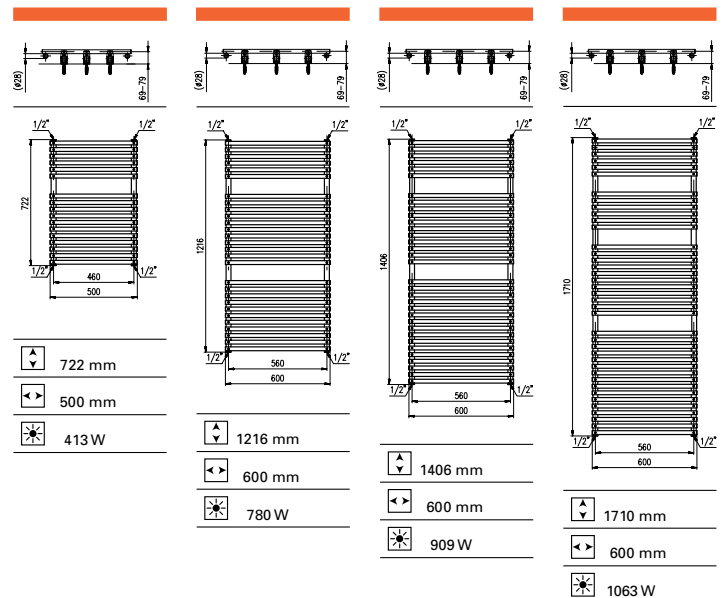

Zie pagina 17 voor alle leverbare kleuren

Inclusief bevestigingsset, montagehandleiding, ontluister en blindstop

Florian dubbel



Vela

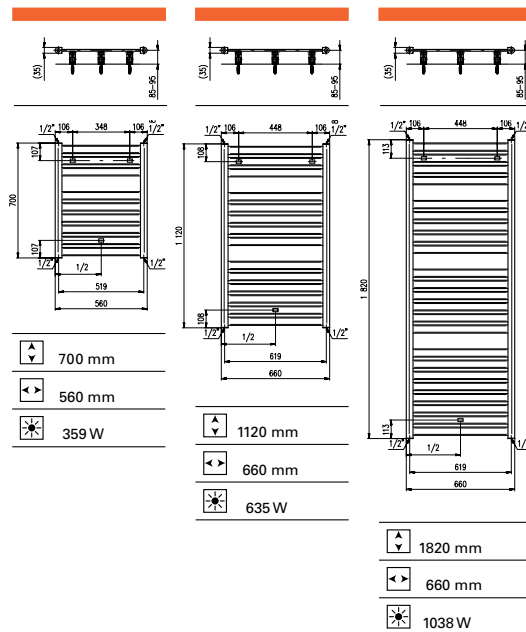
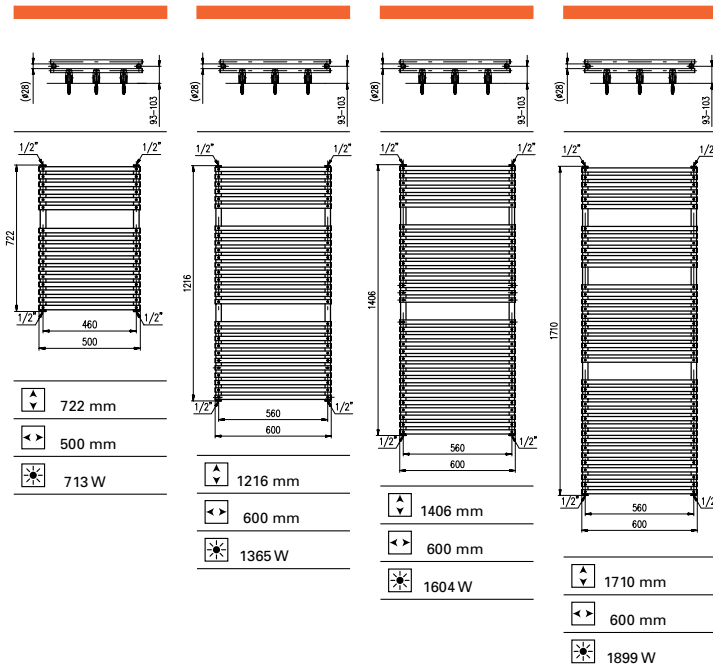

Zie pagina 17 voor alle leverbare kleuren

Inclusief bevestigingsset, montagehandleiding, ontlufter en blindstop

Xilo

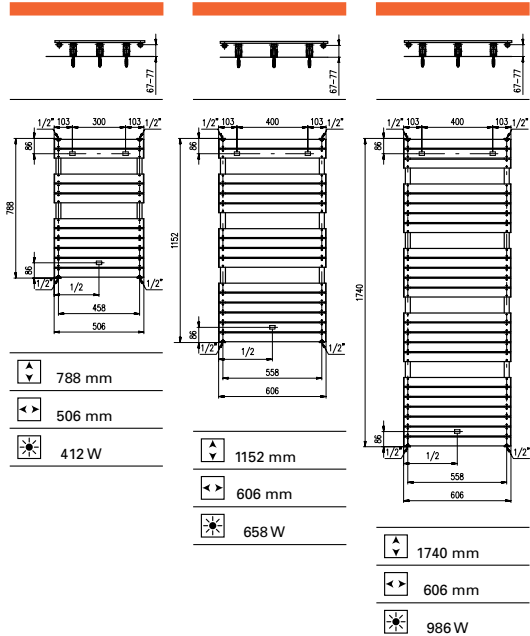

Roma

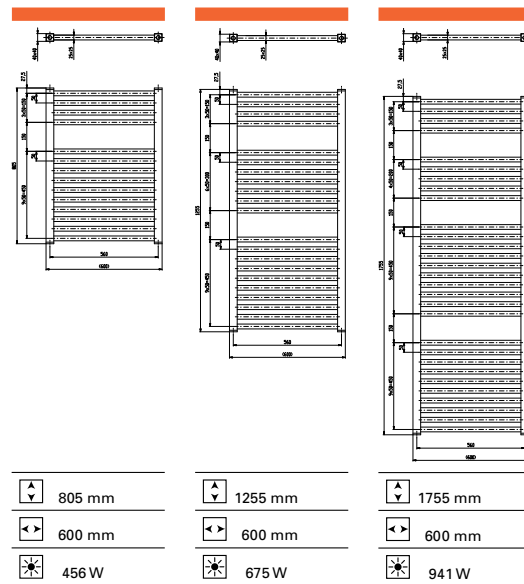

Zie pagina 17 voor alle leverbare kleuren

Inclusief bevestigingsset, montagehandleiding, ontlufter en blindstop

Palmyra

Palmyra gebogen

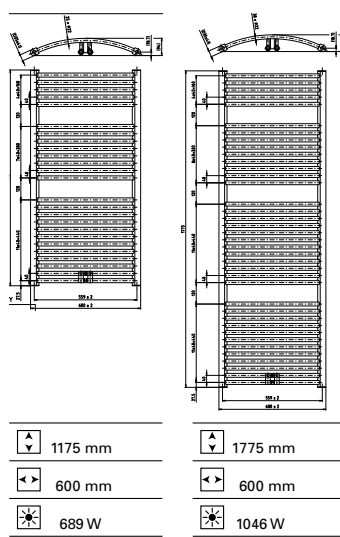
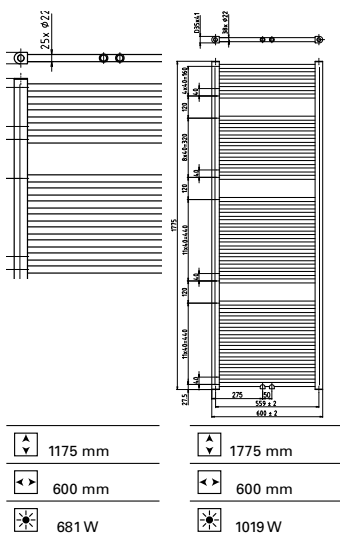

Zie pagina 17 voor alle leverbare kleuren

Inclusief bevestigingsset, montagehandleiding, ontluister en blindstop

Inox

Perugia

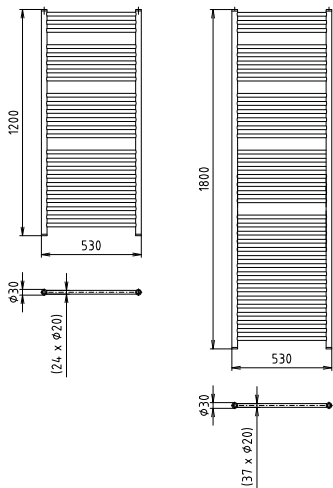
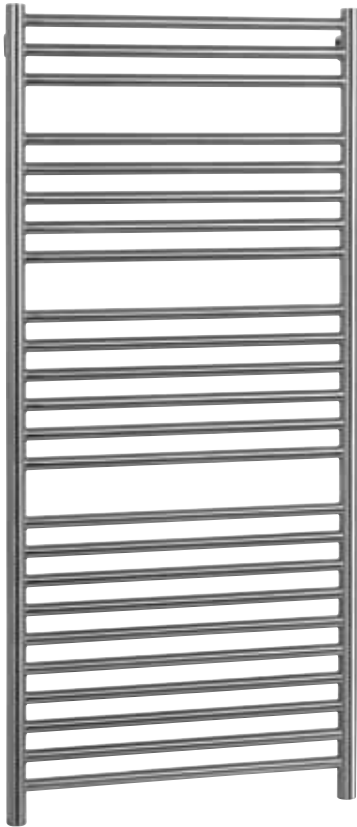

	1200 mm		1800 mm
	535 mm		535 mm
	514 W		771 W

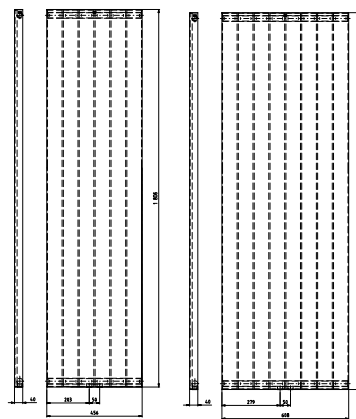

	1806 mm		1806 mm
	456 mm		608 mm
	802 W		1070 W

Zie pagina 17 voor alle leverbare kleuren

Inclusief bevestigingsset, montagehandleiding, ontlufter en blindstop

Venezia enkel

Venezia dubbel

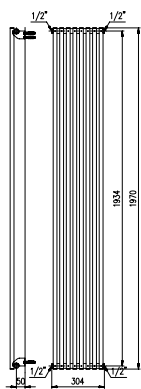
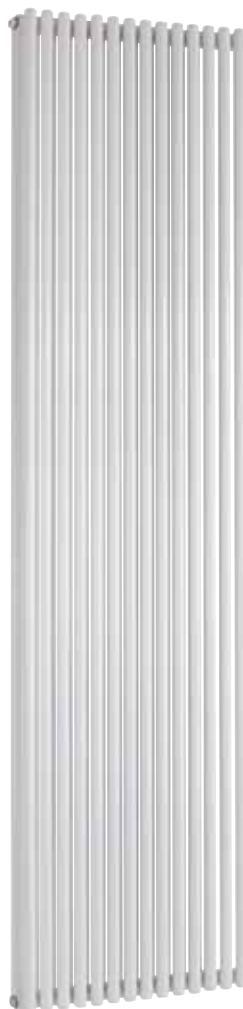
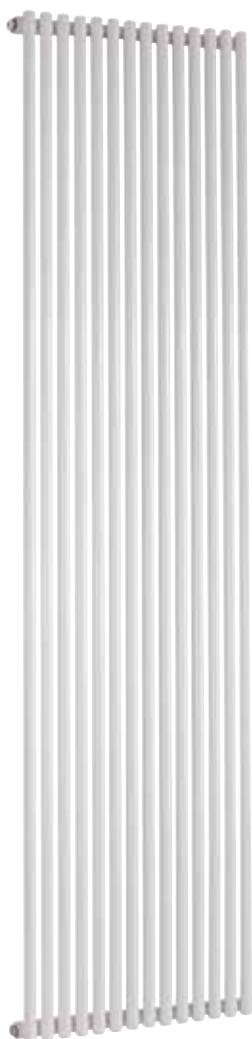

▲	1970 mm
◀▶	304 mm
✱	970 W

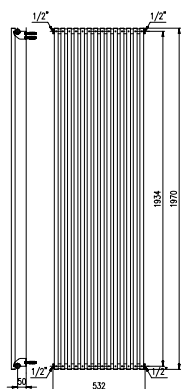

▲	1970 mm
◀▶	532 mm
✱	1417 W

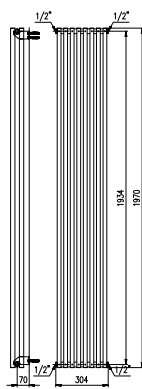

▲	1970 mm
◀▶	304 mm
✱	1168 W

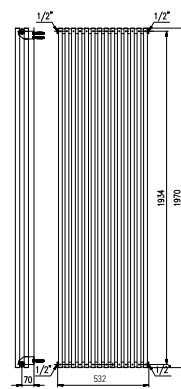

▲	1970 mm
◀▶	532 mm
✱	2148 W

Zie pagina 17 voor alle leverbare kleuren

Inclusief bevestigingsset, montagehandleiding, ontlufter en blindstop

Cavallino enkel



Cavallino dubbel

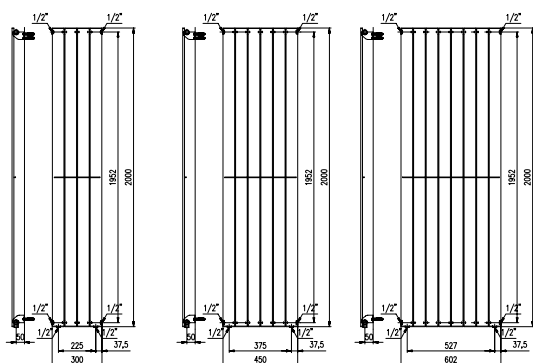

2000 mm	2000 mm	2000 mm
300 mm	450 mm	602 mm
698 W	1046 W	1395 W

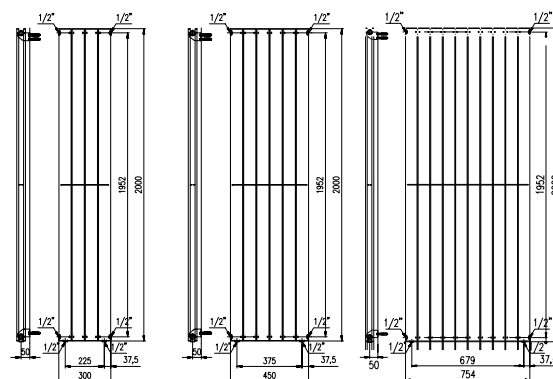

2000 mm	2000 mm	2000 mm
300 mm	450 mm	754 mm
1080 W	1631 W	2718 W

Zie pagina 17 voor alle leverbare kleuren

Inclusief bevestigingsset, montagehandleiding, ontlufter en blindstop

Quadrata

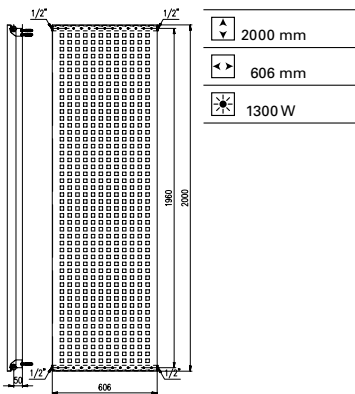
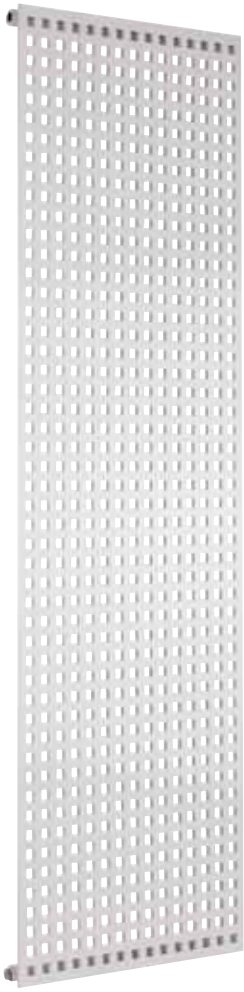

Antika

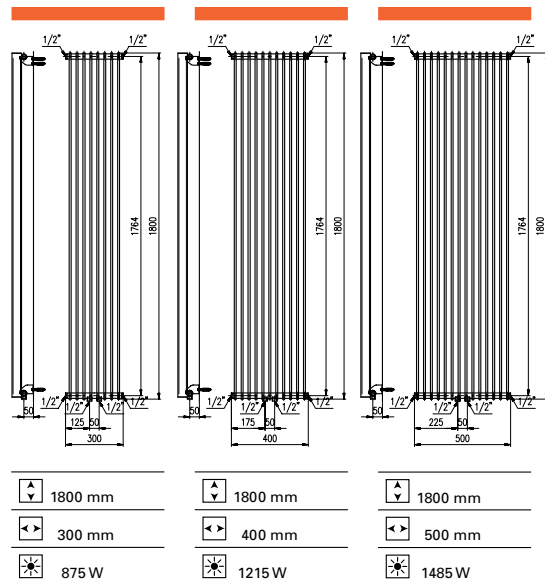

Zie pagina 17 voor alle leverbare kleuren

Inclusief bevestigingsset, montagehandleiding, ontlufter en blindstop

Napoli

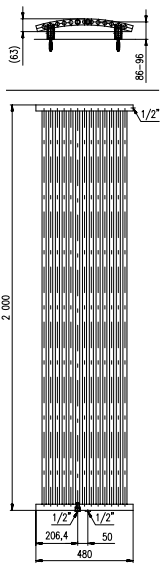
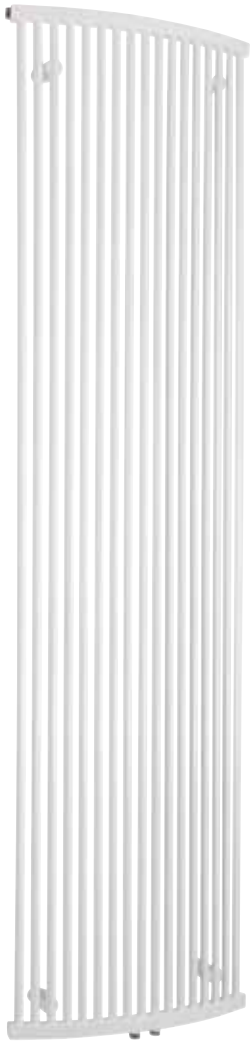

	2000 mm
	480 mm
	885 W

Cavallino dubbel

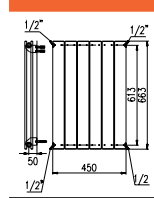

	663 mm
	450 mm
	611 W

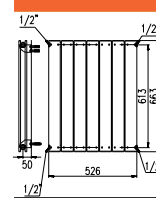

	663 mm
	526 mm
	713 W

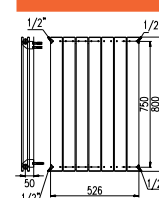

	800 mm
	526 mm
	778 W

Zie pagina 17 voor alle leverbare kleuren
Voir page 17 pour couleurs livrable

Inclusief bevestigingsset, montagehandleiding, ontluchter en blindstop
Inclus : set de fixation, instruction de montage, aérateur et bouchon plein

Pleger model / Pleger modie	Afmeting (hoogtbreedte in mm) / Dimension (hauteur x largeur in mm)	Wattage (W) / Watt (W)	Wit / Blanc		Wit Structuur / Blanc à relief		Mat wit / Blanc terre		Pergamon / Pergamon		Zandsteen / Grès		Zilver Metallic / Argent métallisé		Pearl Grey / Pearl Grey		Alu / Alu		Donker grijs / gris foncé		Antraciet Metallic / Anthracite métal		Black Graphite / Black Graphite		Zwart / Noir		Chroom		
			Wit	Blanc	Wit Structuur	Blanc à relief	Mat wit	Blanc terre	Pergamon	Pergamon	Zandsteen	Grès	Zilver Metallic	Argent métallisé	Pearl Grey	Pearl Grey	Alu	Alu	Donker grijs	gris foncé	Antraciet Metallic	Anthracite métal	Black Graphite	Black Graphite	Zwart	Noir			
Antika	1800x300	875	871123819574	8711238225676	8711238225906	8711238225937	8711238225968	8711238225999	8711238226026	8711238226057	8711238226088	8711238226118	8711238226149	8711238226180	8711238226211	8711238226242	8711238226273	8711238226304	8711238226335	8711238226366	8711238226397	8711238226428	8711238226459	8711238226490	8711238226521	8711238226552	N.v.t.		
Antika	1800x400	1215	8711238195131	8711238225883	8711238225913	8711238225944	8711238225975	8711238226006	8711238226037	8711238226068	8711238226099	8711238226130	8711238226161	8711238226192	8711238226223	8711238226254	8711238226285	8711238226316	8711238226347	8711238226378	8711238226409	8711238226440	8711238226471	8711238226502	8711238226533	8711238226564	N.v.t.		
Arinka	1800x525	1485	8711238195181	8711238224872	8711238224902	8711238224933	8711238224964	8711238224995	8711238225026	8711238225057	8711238225088	8711238225119	8711238225150	8711238225181	8711238225212	8711238225243	8711238225274	8711238225305	8711238225336	8711238225367	8711238225398	8711238225429	8711238225460	8711238225491	8711238225522	8711238225553	8711238225584	N.v.t.	
Cavallino dubbel	663x450	611	8711238075191	8711238224672	8711238224702	8711238224733	8711238224764	8711238224795	8711238224826	8711238224857	8711238224888	8711238224919	8711238224950	8711238224981	8711238225012	8711238225043	8711238225074	8711238225105	8711238225136	8711238225167	8711238225198	8711238225229	8711238225260	8711238225291	8711238225322	8711238225353	8711238225384	N.v.t.	
Cavallino dubbel	663x525	713	8711238075199	8711238224689	8711238224719	8711238224750	8711238224781	8711238224812	8711238224843	8711238224874	8711238224905	8711238224936	8711238224967	8711238224998	8711238225029	8711238225060	8711238225091	8711238225122	8711238225153	8711238225184	8711238225215	8711238225246	8711238225277	8711238225308	8711238225339	8711238225370	8711238225401	N.v.t.	
Cavallino dubbel	800x525	778	8711238075204	8711238224966	8711238224996	8711238225027	8711238225058	8711238225089	8711238225120	8711238225151	8711238225182	8711238225213	8711238225244	8711238225275	8711238225306	8711238225337	8711238225368	8711238225399	8711238225430	8711238225461	8711238225492	8711238225523	8711238225554	8711238225585	8711238225616	8711238225647	8711238225678	N.v.t.	
Cavallino dubbel	2000x300	1080	8711238195956	8711238229579	8711238229609	8711238229640	8711238229671	8711238229702	8711238229733	8711238229764	8711238229795	8711238229826	8711238229857	8711238229888	8711238229919	8711238229950	8711238229981	8711238230012	8711238230043	8711238230074	8711238230105	8711238230136	8711238230167	8711238230198	8711238230229	8711238230260	8711238230291	8711238230322	N.v.t.
Cavallino dubbel	2000x450	1631	8711238075167	8711238225666	8711238225696	8711238225727	8711238225758	8711238225789	8711238225820	8711238225851	8711238225882	8711238225913	8711238225944	8711238225975	8711238225996	8711238226027	8711238226058	8711238226089	8711238226120	8711238226151	8711238226182	8711238226213	8711238226244	8711238226275	8711238226306	8711238226337	8711238226368	N.v.t.	
Cavallino dubbel	2000x750	2718	8711238075174	8711238225933	8711238225963	8711238225994	8711238226025	8711238226056	8711238226087	8711238226118	8711238226149	8711238226180	8711238226211	8711238226242	8711238226273	8711238226304	8711238226335	8711238226366	8711238226397	8711238226428	8711238226459	8711238226490	8711238226521	8711238226552	8711238226583	8711238226614	8711238226645	N.v.t.	
Cavallino enkel	2000x300	698	8711238075099	8711238225272	8711238225302	8711238225333	8711238225364	8711238225395	8711238225426	8711238225457	8711238225488	8711238225519	8711238225550	8711238225581	8711238225612	8711238225643	8711238225674	8711238225705	8711238225736	8711238225767	8711238225798	8711238225829	8711238225860	8711238225891	8711238225922	8711238225953	8711238225984	N.v.t.	
Cavallino enkel	2000x450	1046	8711238075105	8711238225289	8711238225319	8711238225350	8711238225381	8711238225412	8711238225443	8711238225474	8711238225505	8711238225536	8711238225567	8711238225598	8711238225629	8711238225660	8711238225691	8711238225722	8711238225753	8711238225784	8711238225815	8711238225846	8711238225877	8711238225908	8711238225939	8711238225970	8711238226001	N.v.t.	
Cavallino enkel	2000x600	1395	8711238075112	8711238223278	8711238223308	8711238223339	8711238223370	8711238223401	8711238223432	8711238223463	8711238223494	8711238223525	8711238223556	8711238223587	8711238223618	8711238223649	8711238223680	8711238223711	8711238223742	8711238223773	8711238223804	8711238223835	8711238223866	8711238223897	8711238223928	8711238223959	8711238223990	N.v.t.	
Cavallino enkel	2000x450	1046	8711238075105	8711238225289	8711238225319	8711238225350	8711238225381	8711238225412	8711238225443	8711238225474	8711238225505	8711238225536	8711238225567	8711238225598	8711238225629	8711238225660	8711238225691	8711238225722	8711238225753	8711238225784	8711238225815	8711238225846	8711238225877	8711238225908	8711238225939	8711238225970	8711238226001	N.v.t.	
Cavallino enkel	2000x600	1395	8711238075112	8711238223278	8711238223308	8711238223339	8711238223370	8711238223401	8711238223432	8711238223463	8711238223494	8711238223525	8711238223556	8711238223587	8711238223618	8711238223649	8711238223680	8711238223711	8711238223742	8711238223773	8711238223804	8711238223835	8711238223866	8711238223897	8711238223928	8711238223959	8711238223990	N.v.t.	
Cavallino enkel	2000x450	1046	8711238075105	8711238225289	8711238225319	8711238225350	8711238225381	8711238225412	8711238225443	8711238225474	8711238225505	8711238225536	8711238225567	8711238225598	8711238225629	8711238225660	8711238225691	8711238225722	8711238225753	8711238225784	8711238225815	8711238225846	8711238225877	8711238225908	8711238225939	8711238225970	8711238226001	N.v.t.	
Cavallino enkel	2000x600	1395	8711238075112	8711238223278	8711238223308	8711238223339	8711238223370	8711238223401	8711238223432	8711238223463	8711238223494	8711238223525	8711238223556	8711238223587	8711238223618	8711238223649	8711238223680	8711238223711	8711238223742	8711238223773	8711238223804	8711238223835	8711238223866	8711238223897	8711238223928	8711238223959	8711238223990	N.v.t.	
Cavallino enkel	2000x450	1046	8711238075105	8711238225289	8711238225319	8711238225350	8711238225381	8711238225412	8711238225443	8711238225474	8711238225505	8711238225536	8711238225567	8711238225598	8711238225629	8711238225660	8711238225691	8711238225722	8711238225753	8711238225784	8711238225815	8711238225846	8711238225877	8711238225908	8711238225939	8711238225970	8711238226001	N.v.t.	
Cavallino enkel	2000x600	1395	8711238075112	8711238223278	8711238223308	8711238223339	8711238223370	8711238223401	8711238223432	8711238223463	8711238223494	8711238223525	8711238223556	8711238223587	8711238223618	8711238223649	8711238223680	8711238223711	8711238223742	8711238223773	8711238223804	8711238223835	8711238223866	8711238223897	8711238223928	8711238223959	8711238223990	N.v.t.	
Cavallino enkel	2000x450	1046	8711238075105	8711238225289	8711238225319	8711238225350	8711238225381	8711238225412	8711238225443	8711238225474	8711238225505	8711238225536	8711238225567	8711238225598	8711238225629	8711238225660	8711238225691	8711238225722	8711238225753	8711238225784	8711238225815	8711238225846	8711238225877	8711238225908	8711238225939	8711238225970	8711238226001	N.v.t.	
Cavallino enkel	2000x600	1395	8711238075112	8711238223278	8711238223308	8711238223339	8711238223370	8711238223401	8711238223432	8711238223463	8711238223494	8711238223525	8711238223556	8711238223587	8711238223618	8711238223649	8711238223680	8711238223711	8711238223742	8711238223773	8711238223804	8711238223835	8711238223866	8711238223897	8711238223928	8711238223959	8711238223990	N.v.t.	
Cavallino enkel	2000x450	1046	8711238075105	8711238225289	8711238225319	8711238225350	8711238225381	8711238225412	8711238225443	8711238225474	8711238225505	8711238225536	8711238225567	8711238225598	8711238225629	8711238225660	8711238225691	8711238225722	8711238225753	8711238225784	8711238225815	8711238225846	8711238225877	8711238225908	8711238225939	8711238225970	8711238226001	N.v.t.	
Cavallino enkel	2000x600	1395	8711238075112	8711238223278	8711238223308	8711238223339	8711238223370	8711238223401	8711238223432	8711238223463	8711238223494	8711238223525	8711238223556	8711238223587	8711238223618	8711238223649	8711238223680	8711238223711	8711238223742	8711238223773	8711238223804	8711238223835	8711238223866	8711238223897	8711238223928	8711238223959	8711238223990	N.v.t.	
Cavallino enkel	2000x450	1046	8711238075105	8711238225289	8711238225319	8711238225350	8711238225381	8711238225412	8711238225443	8711238225474	8711238225505	8711238225536	8711238225567	8711238225598	8711238225629	8711238225660	8711238225691	8711238225722	871123822575										

Kleuren overzicht

Wit	
Wit structuur	
Mat wit	
Pergamon	
Zandsteen	
Zilver metallic	
Pearl grey	
Alu	
Donker grijs	
Antraciet metallic	
Black graphite	
Zwart	

Middenaansluiting radiator haaks



Inclusief thermostatische radiatorkraan

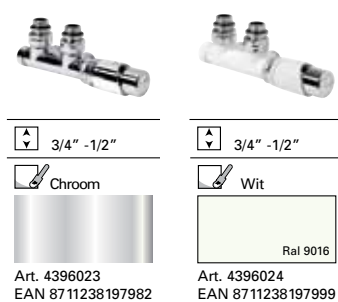

Middenaansluiting voor radiator recht



Inclusief thermostatische radiatorkraan

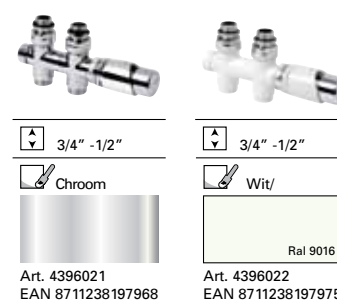

Adapter t.b.v. middenaansluiting

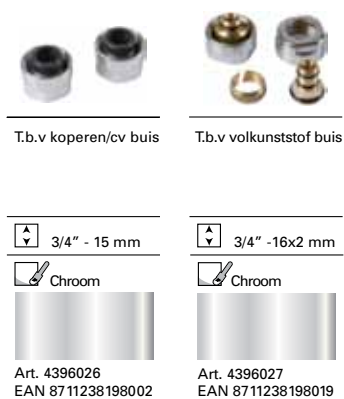

Elektrisch verwarmingselement



Zonder thermostaat

410 mm

300 W

Art. 4396035
EAN 8711238203041

710 mm

600 W

Art. 4396036
EAN 8711238203058

1010 mm

900 W

Art. 4396037
EAN 8711238203065



Met thermostaat

365 mm

300 W

Art. 4396038
EAN 8711238203072

565 mm

600 W

Art. 4396039
EAN 8711238203089

845 mm

900 W

Art. 4396040
EAN 8711238203065

Stromingsbuis universeel



726 mm

Art. 7253000
EAN 8711238150451

1110 mm

Art. 7253005
EAN 8711238150468

1740 mm

Art. 7253010
EAN 8711238150475

Verwarmingselement

U kunt door middel van het verwarmingselement een radiator warm laten worden zonder dat u uw cv-installatie in werking hoeft te stellen. Ideaal om te gebruiken in het voorjaar en najaar wanneer u in de badkamer een behaaglijke temperatuur wenst. Een elektrisch verwarmingselement is ook geschikt voor plaatsen waar u geen cv heeft. U vult de radiator dan met water (niet voor alle modellen geschikt).

Stromingsbuis

Designradiatoren dienen bij voorkeur aan de onderzijde of diagonaal aangesloten te worden (aanvoer aan bovenzijde, afvoer aan onderzijde). Deze buis wordt in de afvoerszijde van de radiator gemonteerd en zorgt ervoor dat de gehele radiator warm wordt. Wanneer de buis ingekort moet worden, zorg er dan voor dat de buis 5 cm korter wordt dan de onderzijde van de radiator, dit voorkomt stromingsgeluiden van het water. Als er geen verticale doorgaande buis in de radiator aanwezig is, kan er geen stromingsbuis worden gemonteerd.

Handdoekhaak 2 stuks



Chroom



Art. 4357056
EAN 8028706046940

Wit



Art. 4357066
EAN 8028706046902

Handdoekstang



370 mm

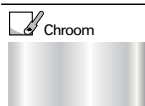

Art. 4357050
EAN 8028706047145

500 mm

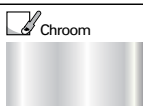

Art. 4357052
EAN 8028706047152



Chroom



Art. 4357070
EAN 8028706047107

370 mm

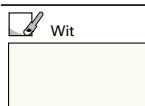

Art. 4357062
EAN 8028706047114

500 mm

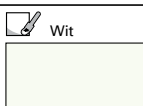

Art. 4357064
EAN 8028706047121



Chroom/Chromé



Art. 4357068
EAN 8028706047022

Perugia / Quadrata / Cavallino

288-304 mm

Art. 4357078
EAN 8711238231099

456-477 mm

Art. 4357079
EAN 8711238231105

603-608 mm

Art. 4357080
EAN 8711238231112

RVS/INOX



Algemene tips

Ventileren:

Zorg ervoor dat uw badkamer goed geventileerd wordt. Hierdoor voorkomt u dat de lak van uw designradiator op lange termijn aangetast wordt door vocht.

Handdoek:

Zorg ervoor dat u de radiator niet gebruikt voor het drogen van uw handdoeken. De radiatoren zijn daar niet voor geschikt. De lak kan hierdoor beschadigen.

Aansluitpunten :

De aansluitpunten van de radiator kunnen roesten door de volgende oorzaken:

- Te weinig teflontape op het draad
- Te strak aangedraaid.

We raden u aan hiermee rekening te houden, zodat de aansluitpunten niet roesten.

Onderhoud

Het mooie uiterlijk van de radiatoren is eenvoudig te onderhouden.

Reinig uw radiator met een vochtige zachte doek of gewoon zeepwater. Voor een extra reinigingsbeurt kan gebruik worden gemaakt van een niet schurend en niet agressief schoonmaakmiddel. Alkalische schoonmaakmiddelen, zuur houdende en schurende middelen kunnen de laklaag van de radiator aantasten, deze schade valt buiten de garantie.

Specificaties

De keuze voor de juiste radiator

Bij aanschaf van een designradiator dient u rekening te houden met de ruimte die u wilt verwarmen. Hierbij speelt de gewenste temperatuur in het te verwarmen vertrek een belangrijke rol.

De aanbevolen rekenformule voor de gewenste warmteafgifte van een radiator is:
 $(l \times b \times h) \times \text{Watt per m}^3$

Ruimte :	°C:	W/m ³ :
Toilet/hal	18	70
Slaapkamer	18	70
Keuken	20	77
Woonkamer	22	85
Badkamer	24	93

Rekenvoorbeeld :

Voor een badkamer van 2 meter lang, 2,5 meter breed en 3 meter hoog is het benodigde vermogen $2 \times 2,5 \times 3 = 15\text{m}^3 \times 93 \text{ Watt per m}^3 = 1395 \text{ Watt}$. In deze badkamer is voor een temperatuur van 24°C dus minimaal een radiator nodig met een capaciteit van 1395 Watt.

Plaatsing designradiator:

Montage van de radiator op de koudste plek in de kamer is aan te raden. Tussen de wand en radiator dient u een minimale ruimte te houden van 5 cm. In grote ruimten is het aan te bevelen meerdere kleinere radiatoren te plaatsen in plaats van één grote.

Tips

- Monteer een thermostatische radiatorkraan nooit met de knop naar boven.
- Wilt u een temperatuur die 2°C hoger is, dan moet u de capaciteit met 10% verhogen.
- Heeft u muurisolatie en / of dubbelglas, dan kan de benodigde capaciteit in het betreffende vertrek met 10% worden verlaagd.
- Indien u in een vrijstaand huis of hoekhuis woont, verhoog dan de benodigde capaciteit met 10%.

Technische specificaties

De warmteafgifte is gebaseerd op een watertemperatuur van 75 °C aanvoer en 65 °C retour bij een kamertemperatuur van 20 °C.

Technische specificaties

Testdruk: 13 Bar
Maximale werkdruk: 10 Bar

Alle aansluitingen hebben een 1/2" inwendige aansluiting.







Plieger B.V.

Zaltbommel (NL)
www.plieger.nl
post@plieger.nl



Plieger B.V. Zaltbommel NL 492.9898 5.1 NL 05-10

Maten en modellen onder voorbehoud



8 711238 083872